

ELEVATION

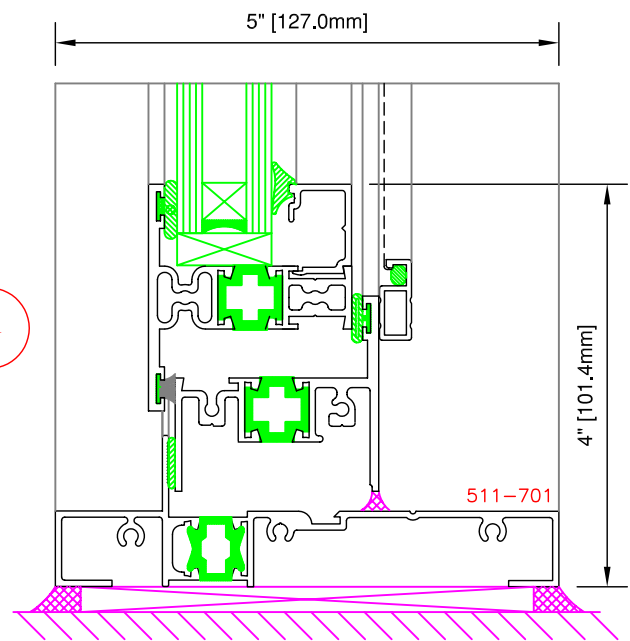

TYPICAL DETAILS

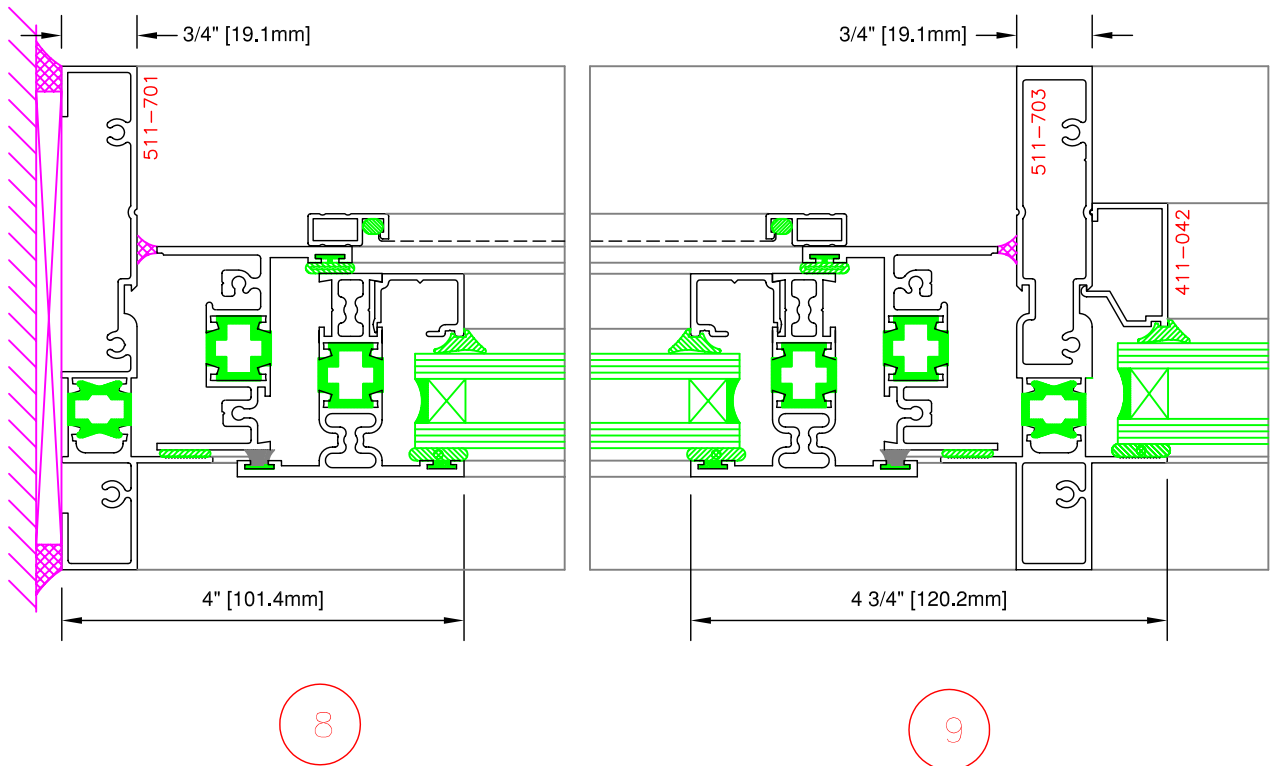
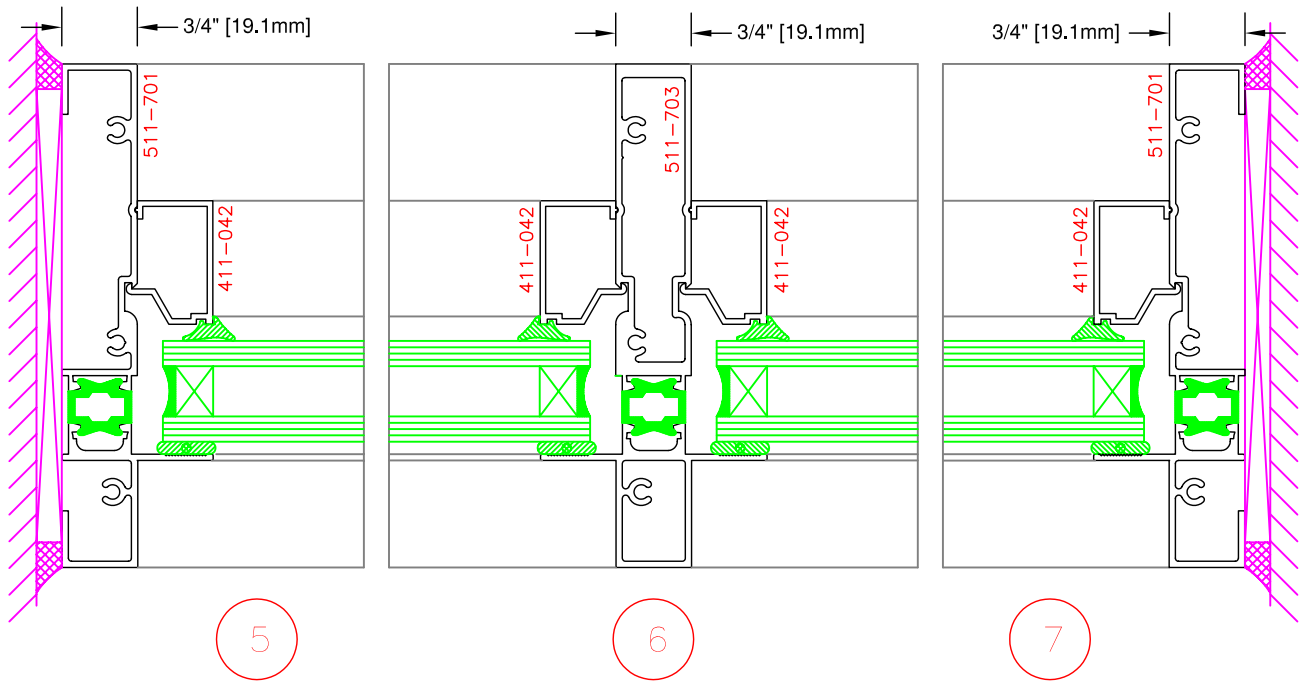

TYPICAL DETAILS

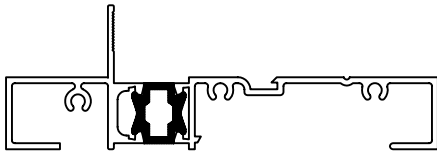

PART #: 510-701
FRAME PERIMETER
4-1/2" (114.3mm)
USE 1/8" GLAZING TAPE

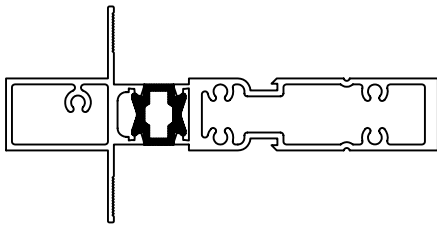

PART #: 510-703
MULLION
4-1/2" (114.3mm)
USE 1/8" GLAZING TAPE
[WIND LOAD CHART](#)

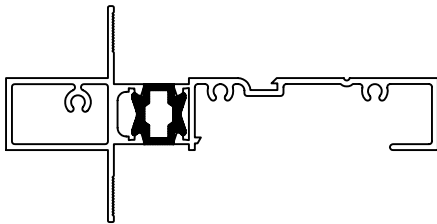

PART #: 510-704
PERIMETER WITH MULLION
FACE
4-1/2" (114.3mm)
USE 1/8" GLAZING TAPE

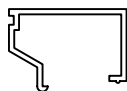

PART #: 411-042
GLASS STOP
FOR 1" (25mm)
SEALED UNIT

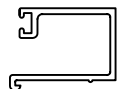

PART #: 411-043
GLASS STOP
FOR 1-7/16" (36mm)
TRIPLE GLAZED

SYSTEM COMPONENTS

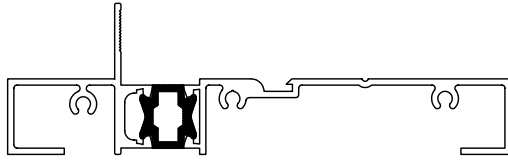

PART #: 511-701
FRAME PERIMETER
5" (127.0mm)
USE 1/8" GLAZING TAPE

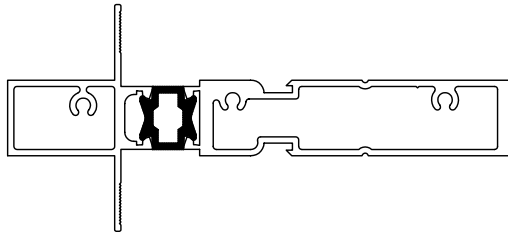

PART #: 511-703
MULLION
5" (127.0mm)
USE 1/8" GLAZING TAPE
[WIND LOAD CHART](#)

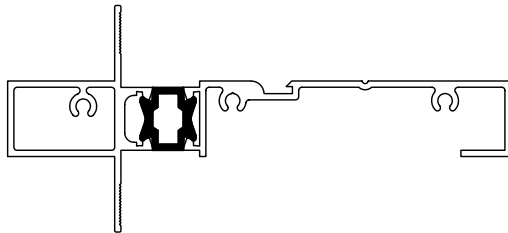

PART #: 511-704
PERIMETER WITH MULLION
FACE
5" (127.0mm)
USE 1/8" GLAZING TAPE

SYSTEM COMPONENTS

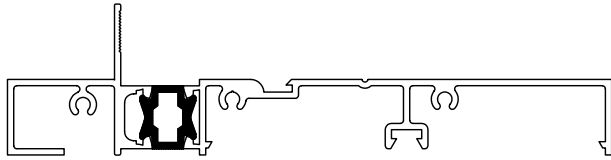

PART #: 512-701
FRAME PERIMETER
6" (152.4mm)
USE 1/8" GLAZING TAPE

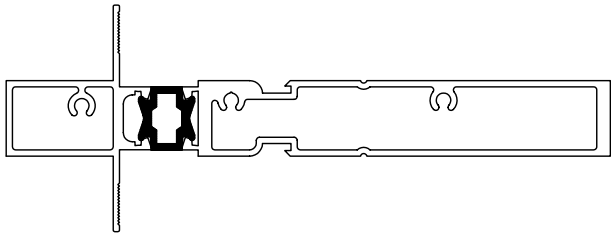

PART #: 512-703
MULLION
6" (152.4mm)
USE 1/8" GLAZING TAPE
[WIND LOAD CHART](#)

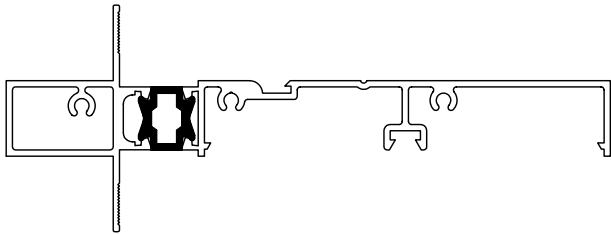

PART #: 512-714
PERIMETER WITH MULLION
FACE
6" (152.4mm)
USE 1/8" GLAZING TAPE

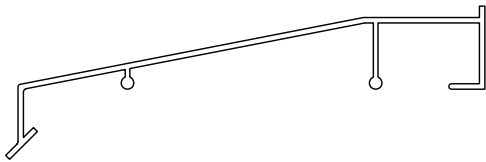

PART #: 411-005
SILL
4-5/8" (117.5mm)
USE UNDER WINDOW FRAME

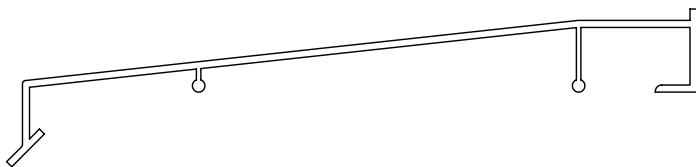

PART #: 411-006
SILL
6-3/4" (171.5mm)
USE UNDER WINDOW FRAME

SYSTEM COMPONENTS

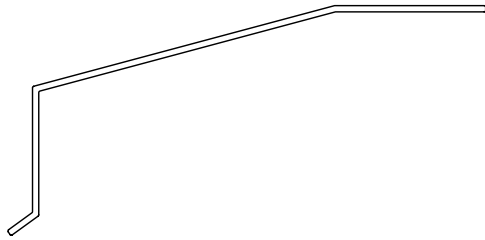

PART #: 411-007
SILL
4-1/2" (114.3mm)
USE UNDER WINDOW FRAME

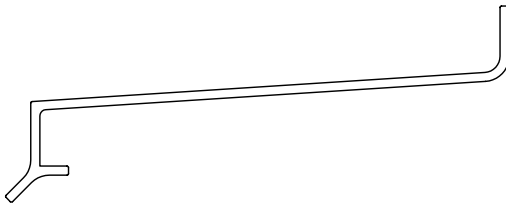

PART #: 411-008
SILL
4-3/4" (120.7mm)
USE UNDER WINDOW FRAME

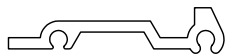

PART #: 411-901
MULLION BRACKET
FITS ALL
MULLION SIZES

SYSTEM COMPONENTS

DRAWING	DESCRIPTION	APPLICATION	QTY/ JOINT
	PART #: 9902-303 # 8 X 1" PH SCREW	TO FASTEN HEAD/SILL TO VERTICAL	3
	PART #: 9902-309 # 8 X 2" ROB. HEAD SCREW	TO FASTEN MULLION BRACKET TO VERT/HORIZ	2
	PART #: 9902-301 # 8 X 5/8" RH TECK SCREW	TO FASTEN MULLION TO BRACKET	2

SYSTEM FASTENERS

DRAWING

DESCRIPTION

APPLICATION



PART #: 9904-001
1/8" POLYSHIM TAPE
BY TREMCO OR EQUAL

APPLY TO
EXTERIOR PERIMETER
1" (25mm) S.U. GLASS



PART #: 9904-002
3/16" POLYSHIM TAPE
BY TREMCO OR EQUAL

APPLY TO
EXTERIOR PERIMETER
15/16" (24mm) S.U.



PART #: 9903-131
GLAZING SPLINE

APPLY TO
GLASS STOP FOR
1" (25mm) S.U.

NOTE: FOR OTHER UNIT THICKNESS, CONTACT
COMMDOOR SALES/SERVICE FOR
RECOMMENDATION



PART #: 9903-132
BULB GASKET

APPLY TO
GLASS STOP FOR
1-1/2" (38mm) S.U.

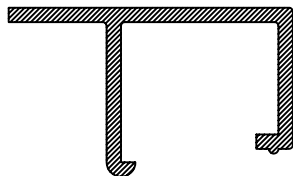

PART #: 9906-001
GLASS STOP PVC

OPTIONAL GLASS STOP
FOR 15/16" (24mm) S.U.
NO SPLINE REQUIRED

SYSTEM GLAZING SPLINE AND WEATHERING

510-703
MULLION
4-1/2" (114.3mm)
USE 1/8" GLAZING TAPE

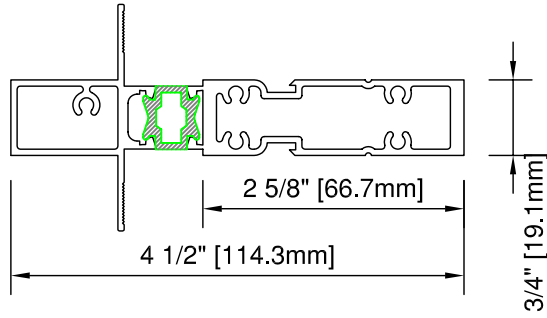

A = 21 psf (1.0 KPa)
B = 25 psf (1.2 KPa)
C = 30 psf (1.4 KPa)
D = 35 psf (1.7 KPa)
E = 40 psf (1.9 KPa)
F = 45 psf (2.1 KPa)

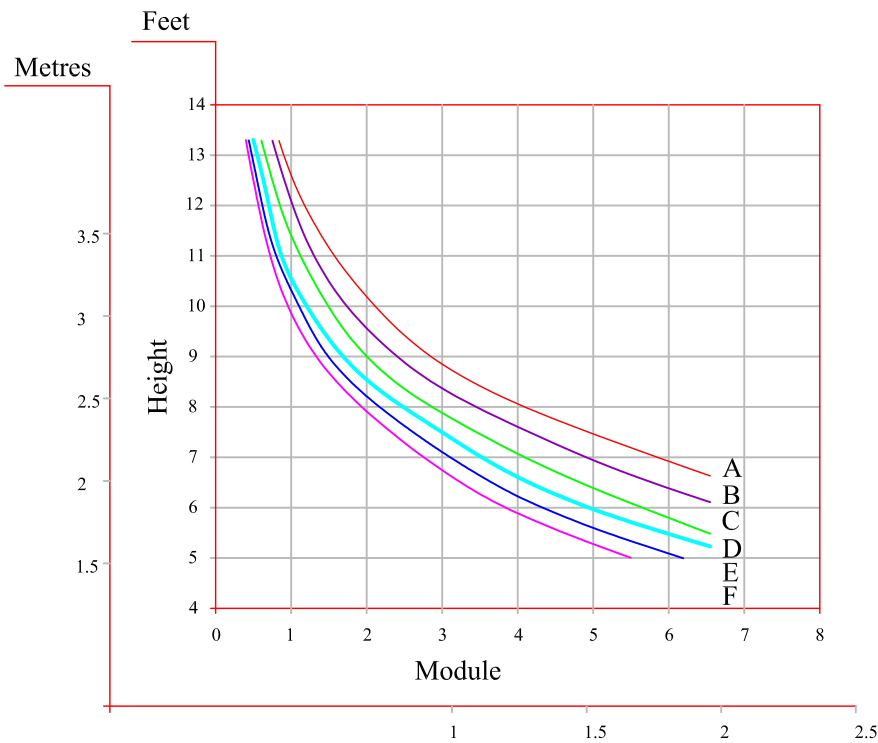

511-703
MULLION
5" (127 mm)
USE 1/8" GLAZING TAPE

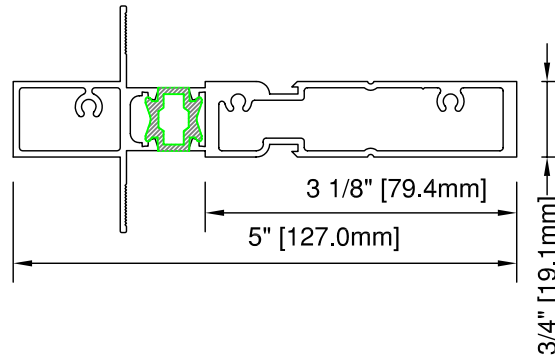

- A = 21 psf (1.0 KPa)
- B = 25 psf (1.2 KPa)
- C = 30 psf (1.4 KPa)
- D = 35 psf (1.7 KPa)
- E = 40 psf (1.9 KPa)
- F = 45 psf (2.1 KPa)

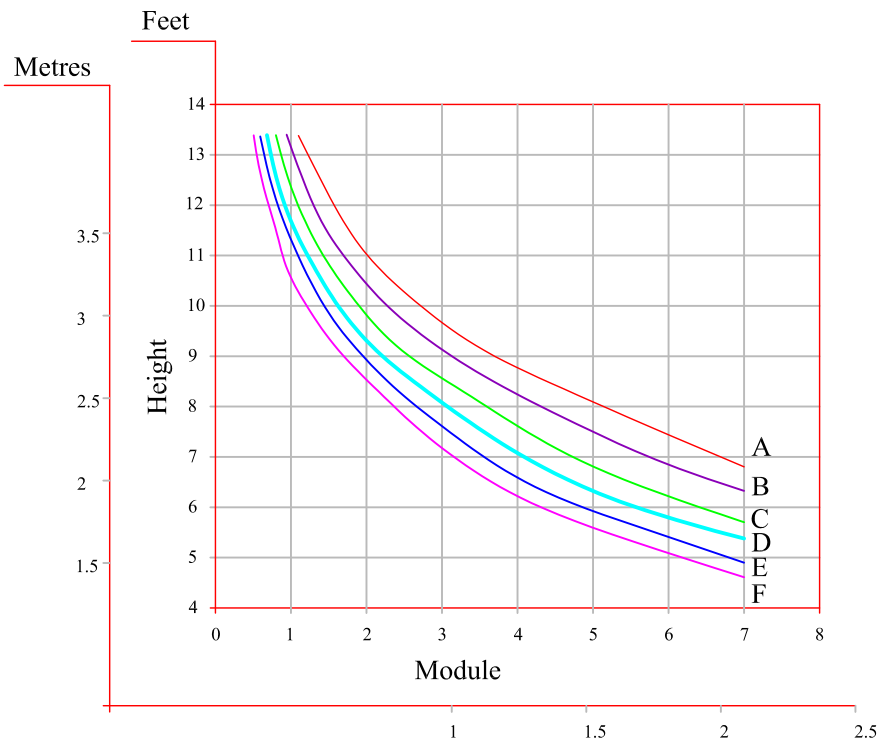

512-703
MULLION
6" (152.4mm)
USE 1/8" GLAZING TAPE

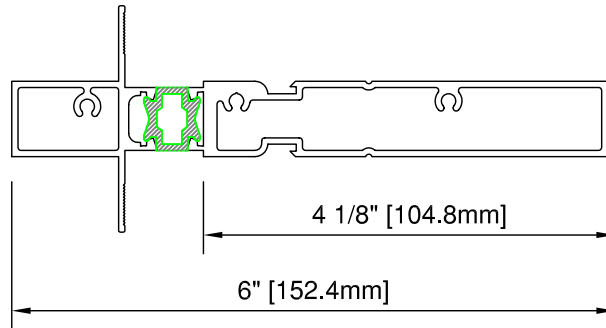

- A = 21 psf (1.0 KPa)
- B = 25 psf (1.2 KPa)
- C = 30 psf (1.4 KPa)
- D = 35 psf (1.7 KPa)
- E = 40 psf (1.9 KPa)
- F = 45 psf (2.1 KPa)

