

DOOR IN "OPEN"
POSITION

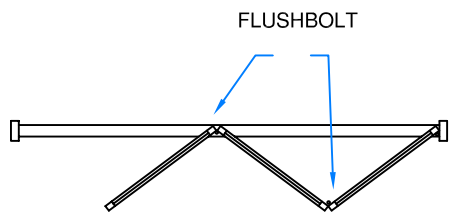
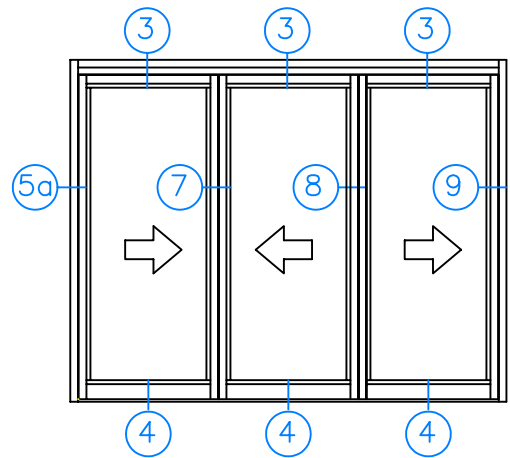

DOOR IN "OPEN"
POSITION

TYPICAL ELEVATIONS

DOOR CONFIGURATIONS

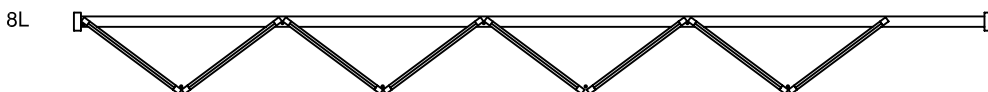
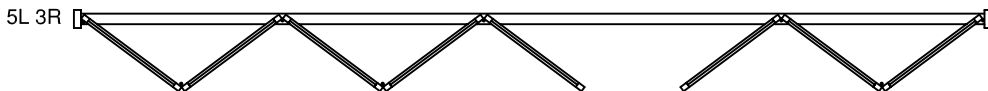
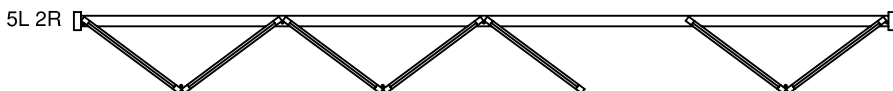
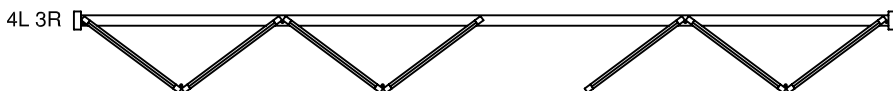
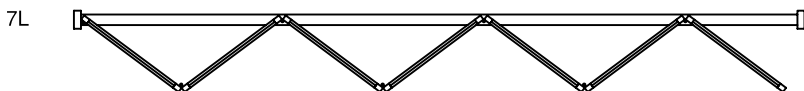
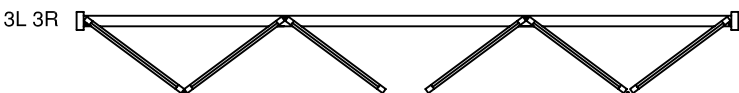
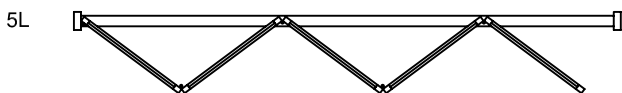
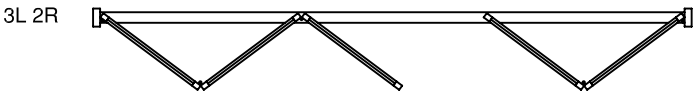
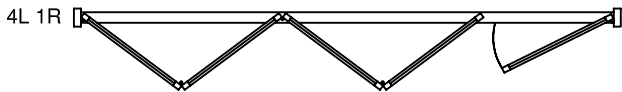
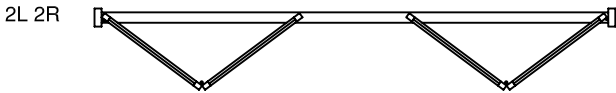
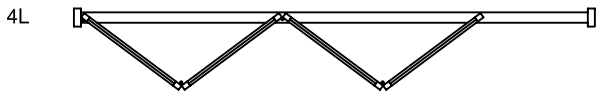
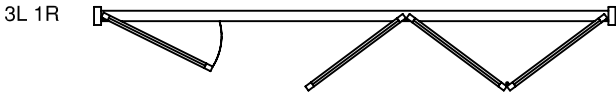
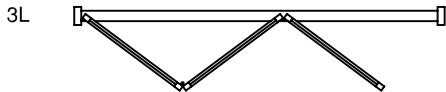
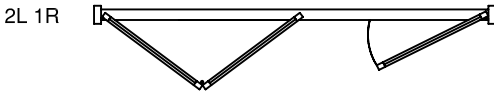
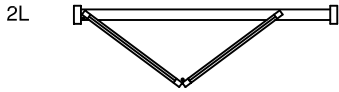

TYPICAL ELEVATIONS

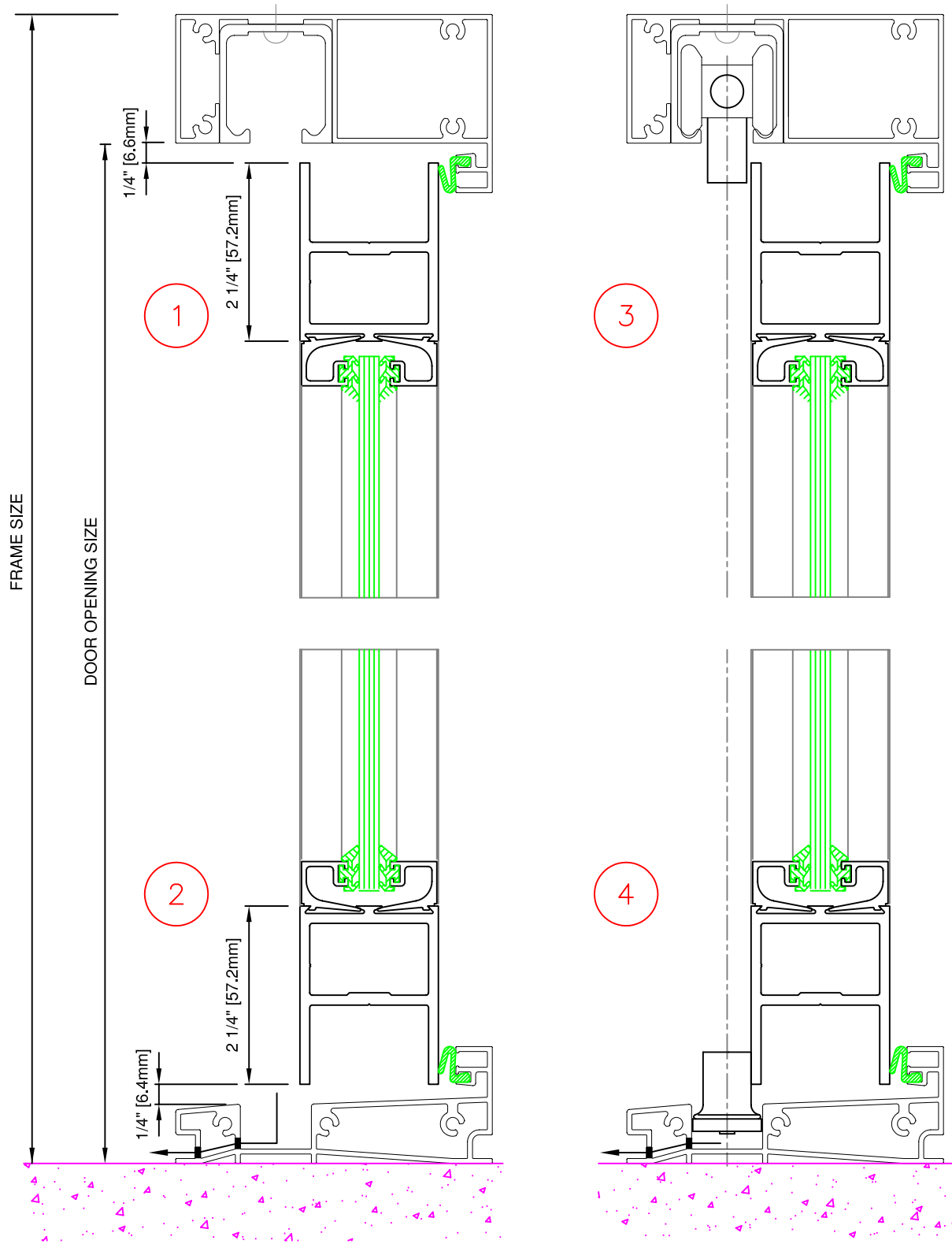

TYPICAL DETAILS

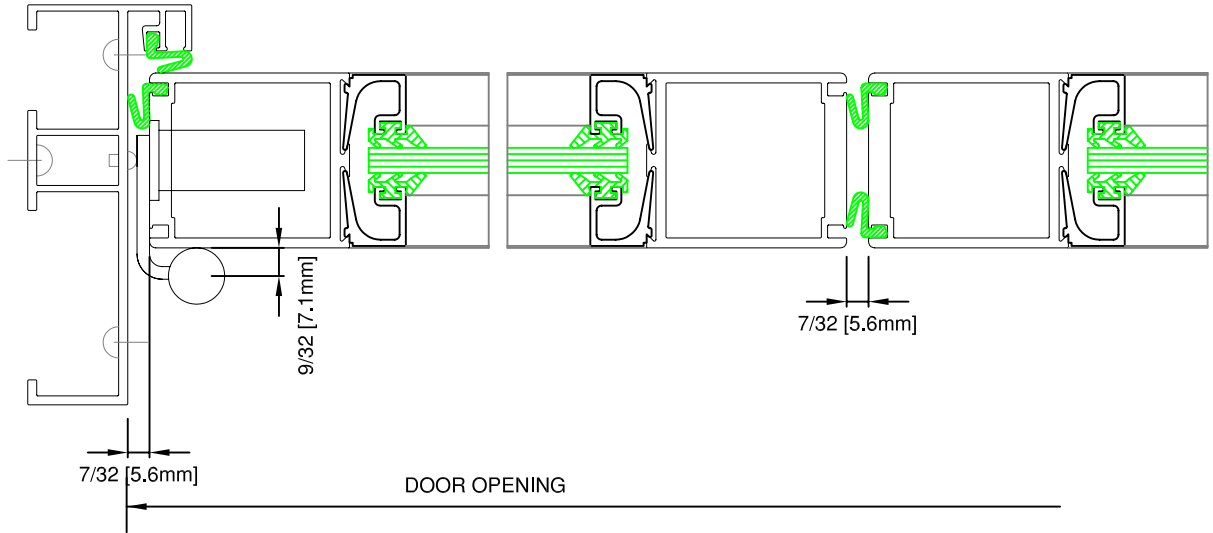

5

6

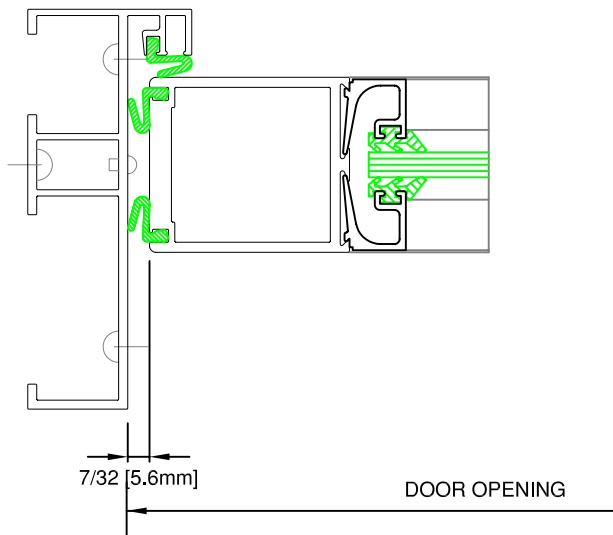

5a

TYPICAL DETAILS

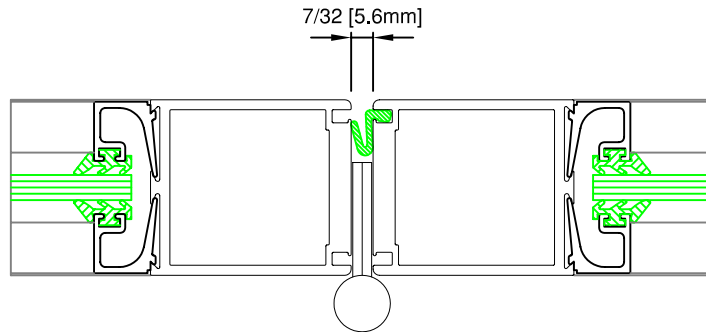

DOOR OPENING

7

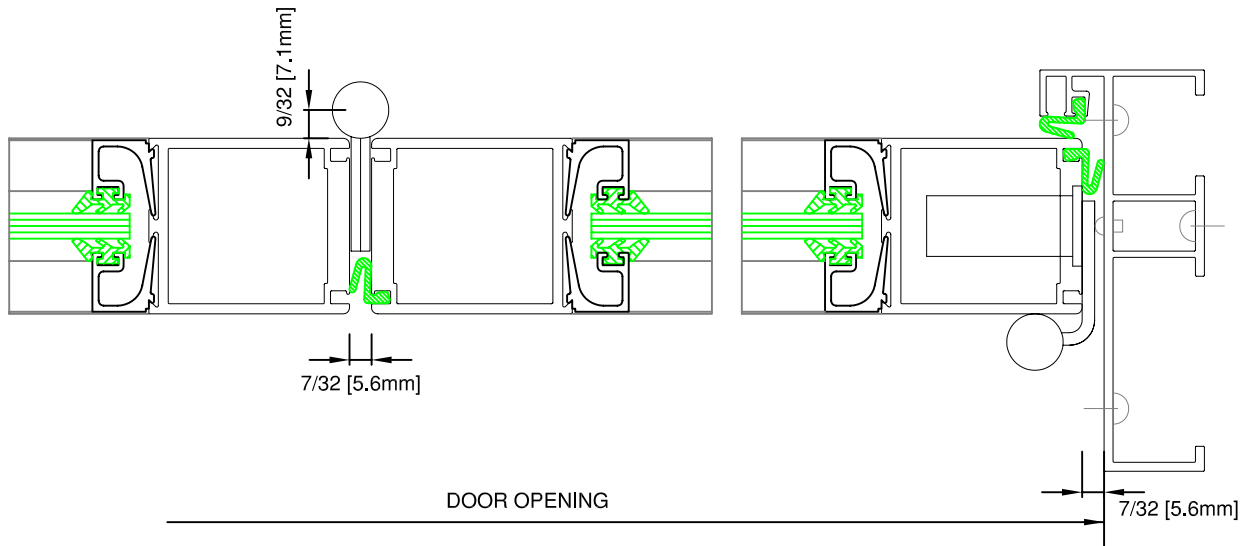

DOOR OPENING

8

9

TYPICAL DETAILS